

Unit 3 Review

1. Identify types of angles

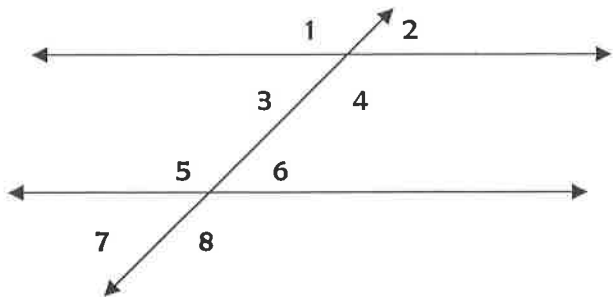

< 1 and < 4: _____

< 5 and < 3: _____

< 2 and < 6: _____

< 1 and < 8: _____

< 3 and < 6: _____

- _____ 2. A regular polygon has
- a. equal sides
 - b. equal angles
 - c. both equal angles and equal sides
 - d. parallel sides

- _____ 3. A scalene triangle has
- a. three equal sides
 - b. two or more equal sides
 - c. no equal sides
 - d. two right angles

- _____ 4. An equiangular polygon has
- a. equal sides
 - b. equal angles
 - c. both equal angles and equal sides
 - d. parallel sides

- _____ 5. An isosceles triangle has
- a. three equal sides
 - b. two or more equal sides
 - c. no equal sides
 - d. two right angles

6. Sketch every axis of symmetry. Note the number of axes.

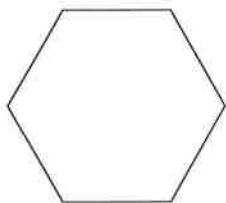

Number of axes:



Number of axes:

7. Determine the order for each figure's rotational symmetry.

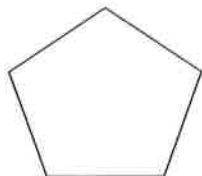

Order :

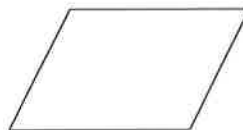

Order:

Formulas for Sum of Interior Angles, Each Angle, Sum of Exterior Angles			
Sum of interior =	Each interior =	Sum of exterior =	Each exterior =

8. What is the sum of the exterior angles of an 11-gon?

12. What is the measure of each interior angle of a regular dodecagon?

9. How many sides would a regular polygon have if the sum of the interior angles is 10,620 degrees?

13. What is the exterior angle at an interior angle of 110 degrees?

10. What is the sum of the interior angles of a 19-gon?

14. What is the measure of each exterior angle of a regular 27-gon?

11. How many sides would a regular polygon have if each exterior angle is 7.5 degrees?

15. How many sides would a regular polygon have if each interior angle is 160 degrees?

Find the value of x .

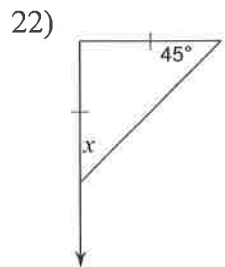
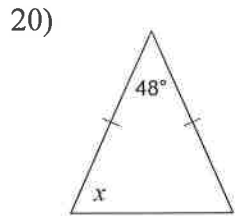
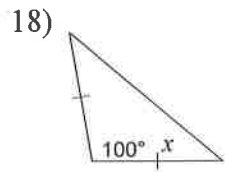

24) $m\angle 2 = x + 68$

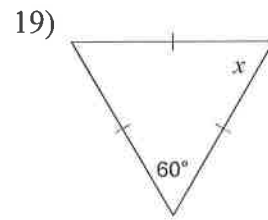
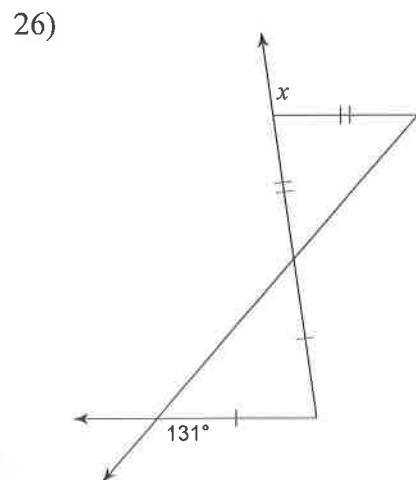
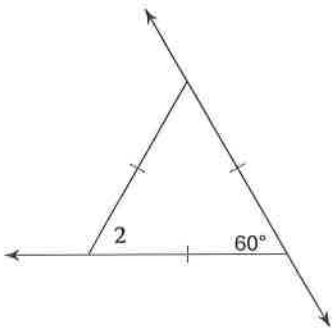

21) $m\angle 2 = 9x + 6$

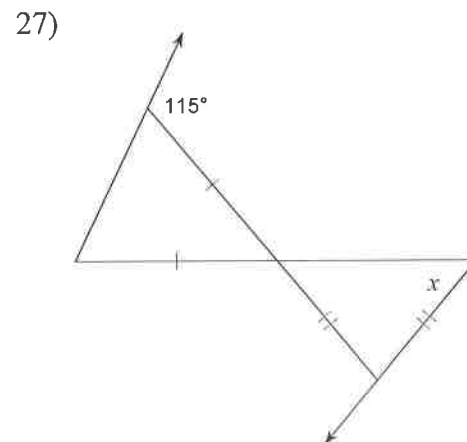
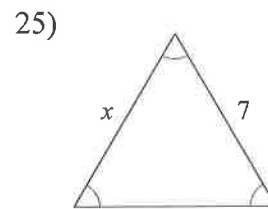
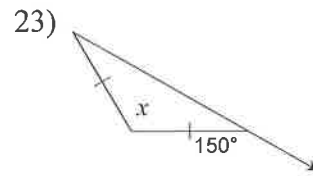
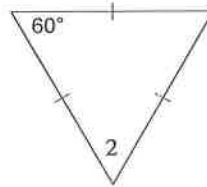

28)

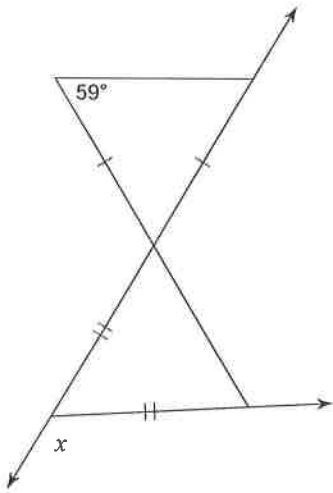

29)

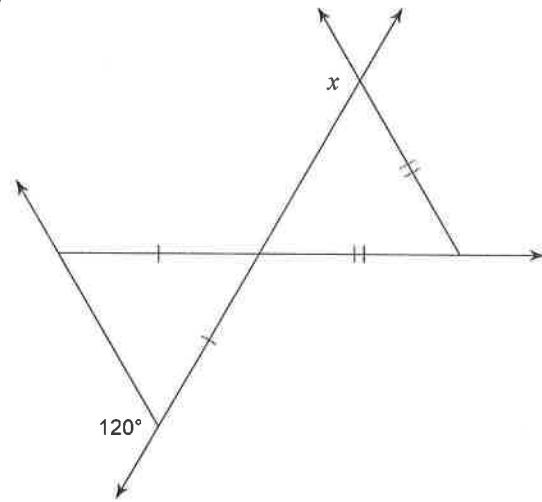

30)

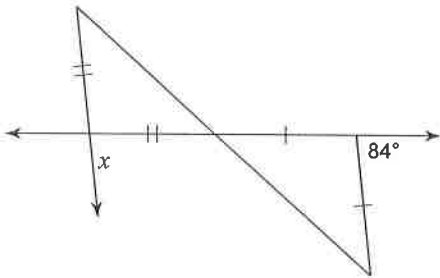

31)

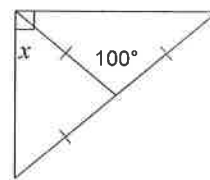

32) $m\angle 2 = x + 78$

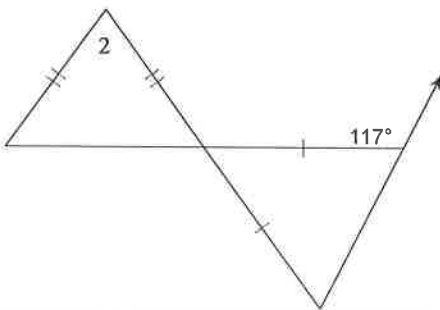

Solve for x.

33)

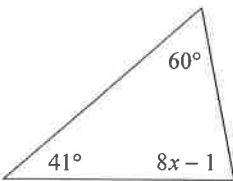

34)

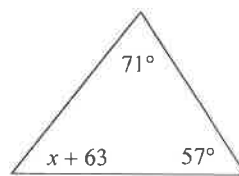

35)

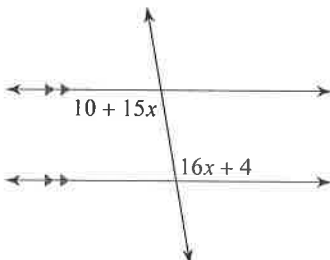

36)

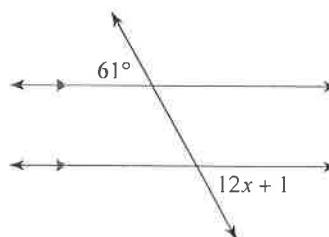

Find the value of x .

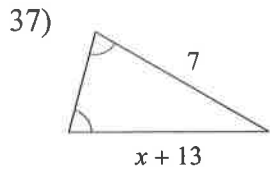

Solve for x .

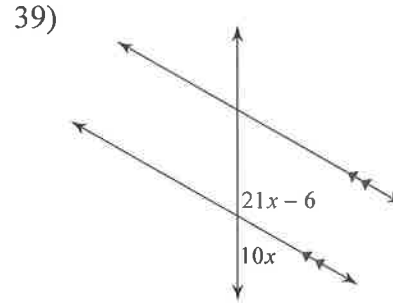
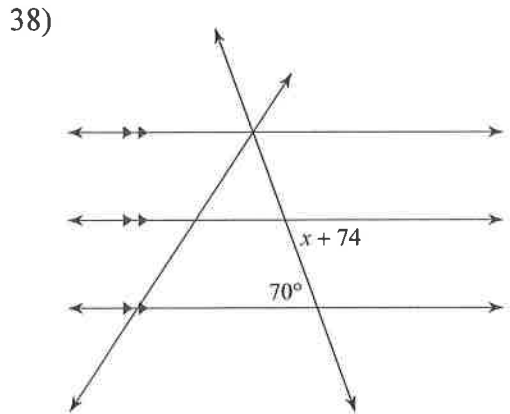

Find the measure of angle A.

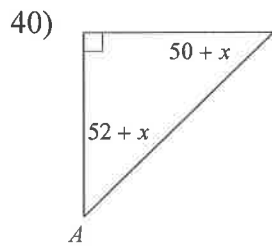

Find the measure of each angle indicated.

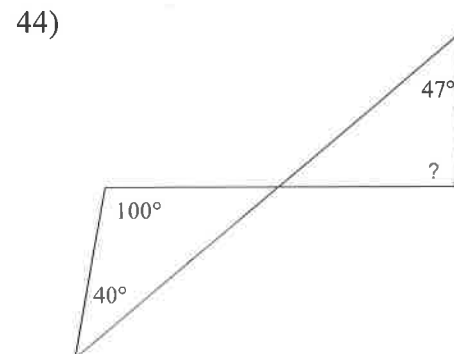
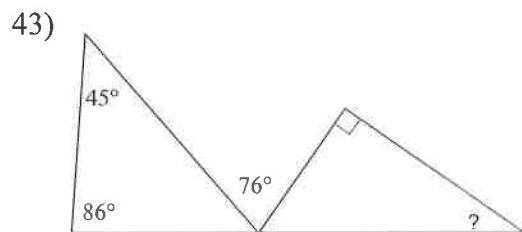
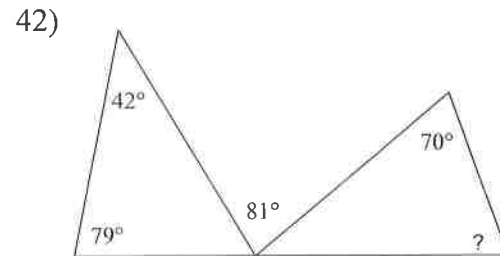
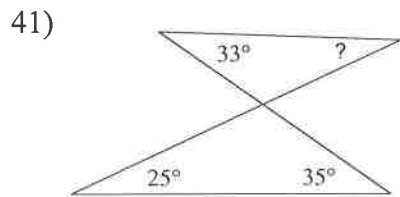

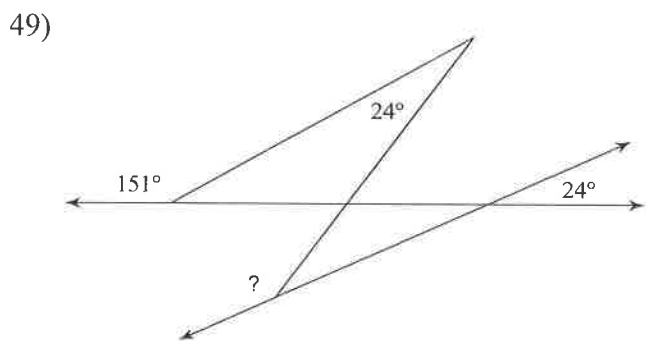
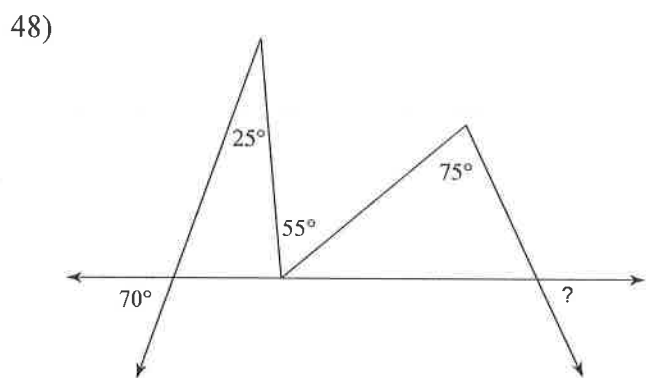
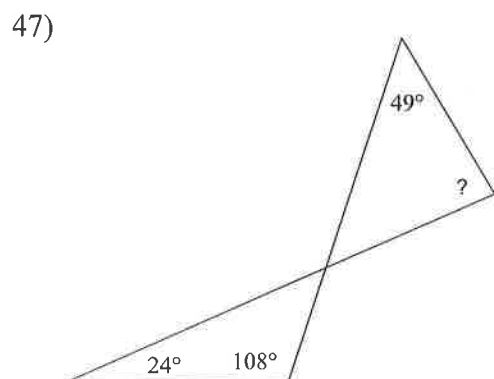
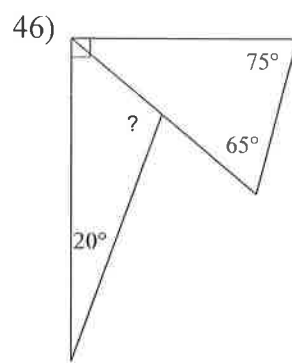
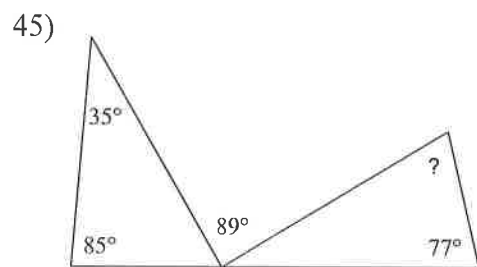

50)

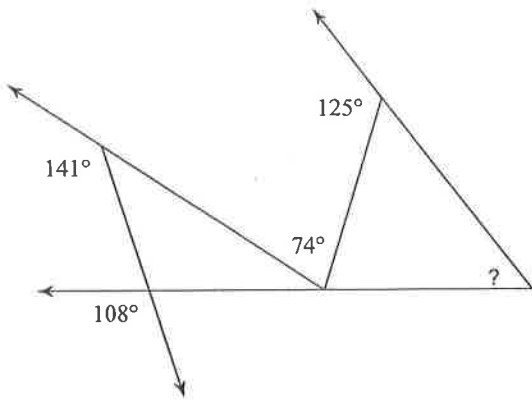

51)

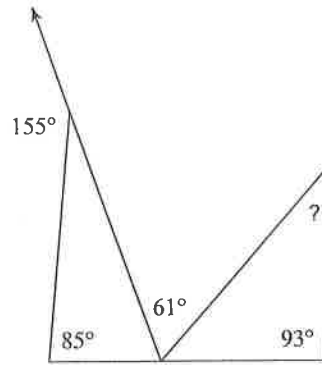

52)

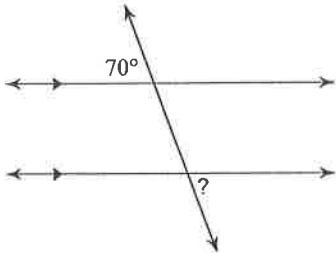

53)

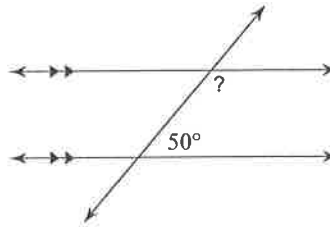

54)

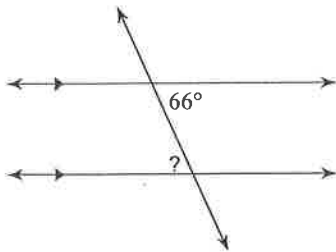

55)

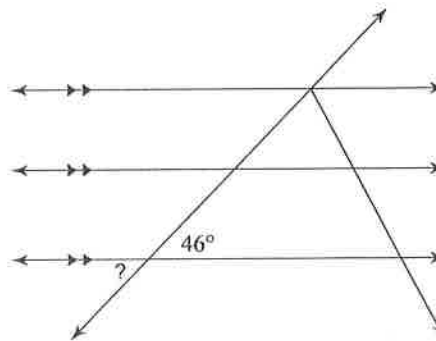

56)

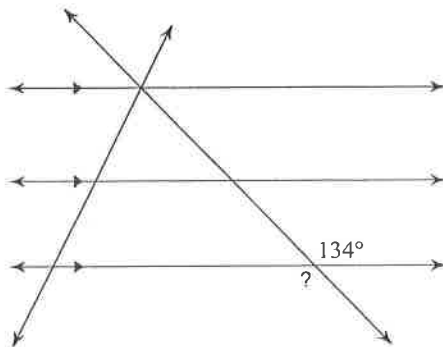

57)

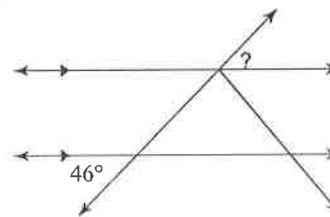

State if the three numbers can be the measures of the sides of a triangle.

58) 8, 3, 8

59) 8, 15, 7

60) 24, 12, 9

61) 10, 19, 9

Two sides of a triangle have the following measures. Find the range of possible measures for the third side.

62) 10, 8

63) 11, 12

64) 9, 7

65) 6, 6

Find the measures of the requested angles.

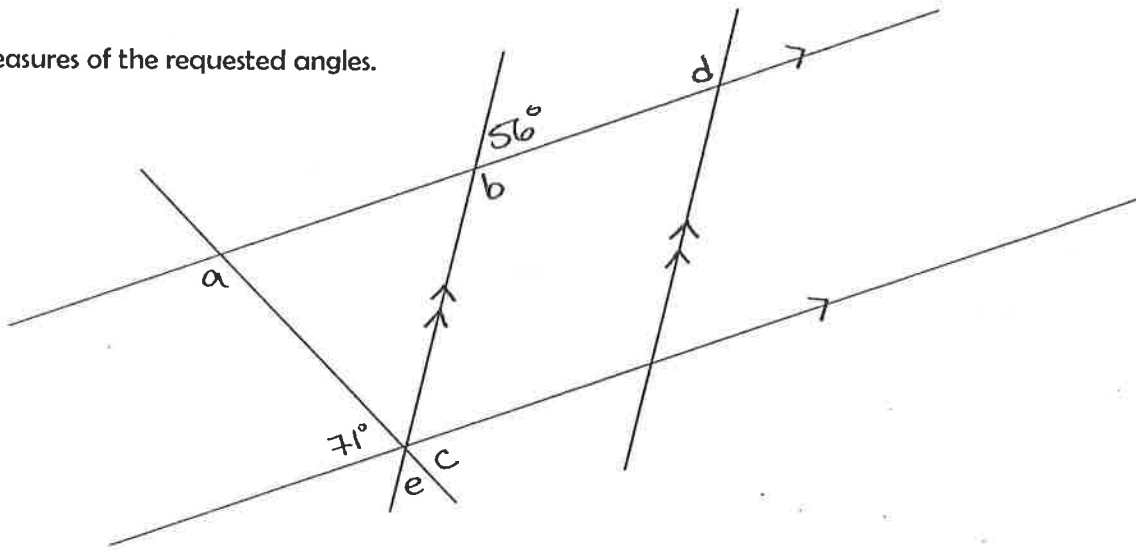

- a. _____ b. _____ c. _____ d. _____ e. _____

Find the measures of the requested angles.

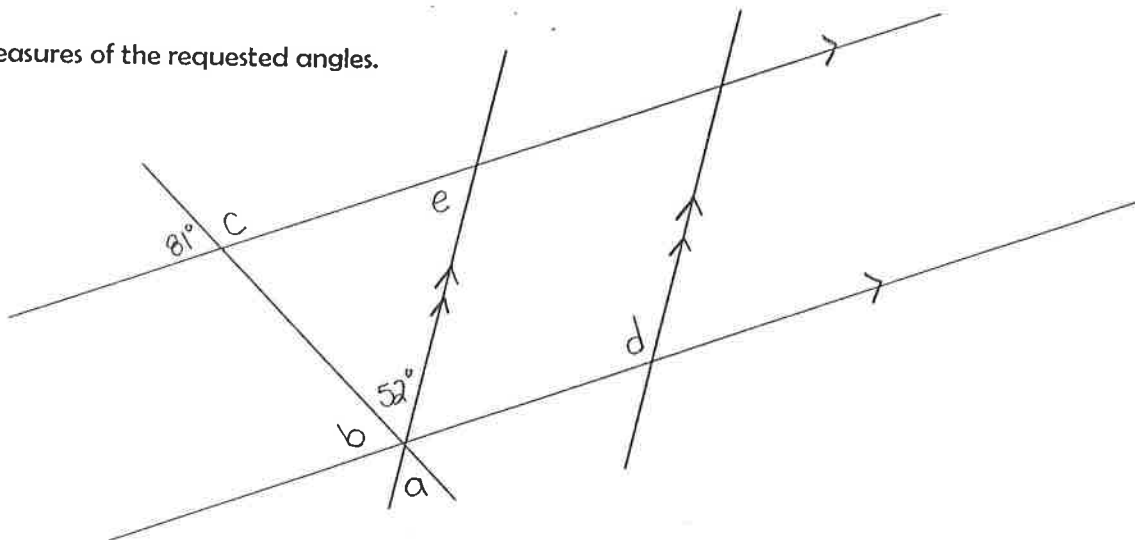

- a. _____ b. _____ c. _____ d. _____ e. _____